

SPECIFICATION SHEET T-680R



QUICKTEMP TECHNOLOGY

QuickTemp technology utilizes an electronic throttling valve system, and is standard on all T-80 Series units. QuickTemp allows you to realize major long-term benefits, including significant fuel savings, improved temperature control and reduced maintenance.



RELIABLE RECIPROCATING COMPRESSOR

The industry standard for proven reliability and easy service.

- High volumetric efficiency vs. other reciprocating compressors due to more pumping capacity per cubic inch
- Reliable, time-tested design
- Field-repairable for easy service
 - No special tools or facilities required
 - Removable and replaceable cast iron cylinder sleeve design

KEY OPTIONS

Customize your unit to fit your business needs:

- | | | |
|--|--|---|
| <input type="checkbox"/> SmartPower™
Electric Standby (230V
or 460V) | <input type="checkbox"/> Top Cover & Screen | <input type="checkbox"/> Electronic Door Switch |
| <input type="checkbox"/> Premium Display | <input type="checkbox"/> Battery Box | <input type="checkbox"/> Body Mount HMI |
| <input type="checkbox"/> Whisper™ Plus Noise
Reduction | <input type="checkbox"/> 30 Gallon Fuel Tank | <input type="checkbox"/> Flush Mount HMI |

System Performance

Refrigeration capacity: System net cooling capacity at 100°F ambient temperature and high speed engine/60 Hertz electric power

Return air to evaporator	35°F	0°F	-20°F
Engine Power BTU/hr (Up to)	18,000	11,000	7,000
Electric Power BTU/hr (Up to)	15,500	10,000	6,000
Heating capacity (35°F/0°F ambient)			
Engine power (BTU/hr)	10,500		
Electric power (BTU/hr)	5,800		
Airflow: on high speed engine operation			
Airflow volume @ 0 Pa static pressure	1600 ft ³ /min		
Discharge Velocity (Air Throw)	18 ft/sec		
Weight (Condensing Unit):			
Standard: cooling/heating on engine operation	963 lbs		
With SmartPower electric standby: cooling/heating on engine/electric standby	1018 lbs		
Engine: 3 cylinder, liquid cooled			
Model	TK 370		
Rating	15 hp		
Maintenance Interval	2000 hrs		
Compressor: lightweight aluminum alloy			
Model	X214		
Displacement	14 cu. in.		
Electric standby motor			
Voltage / phase / cycles	230/3/60		
Rating	7.2 hp		
Refrigerants: R-404A zero Ozone Depletion Potential (ODP), internationally approved			
Charge	7.0 lbs		

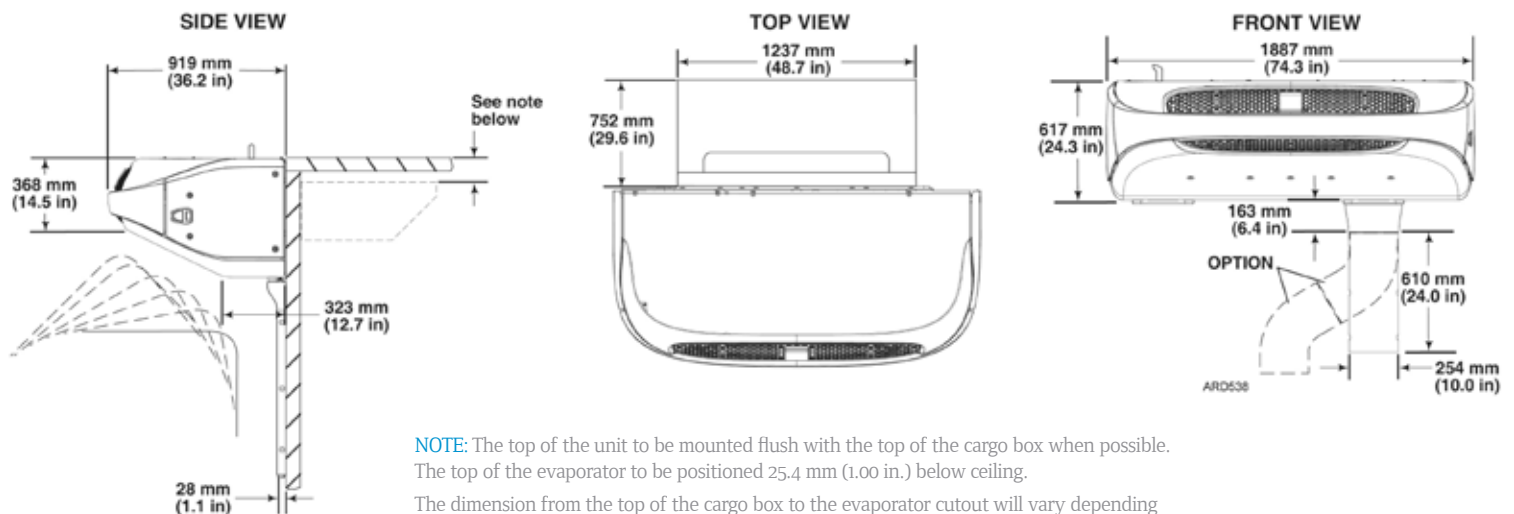

NOTE: The top of the unit to be mounted flush with the top of the cargo box when possible. The top of the evaporator to be positioned 25.4 mm (1.00 in.) below ceiling. The dimension from the top of the cargo box to the evaporator cutout will vary depending on the type of box, truck cab tilt clearance, etc. T-680R and T-880R minimum dimension = 107 mm (4.25 in.)

